



## LEISTUNGSERKLÄRUNG



DoP: 0142

für fischer Rahmendübel FUR (Kunststoffdübel für die Verwendung in Beton und Mauerwerk) – DE

1. Eindeutiger Kenncode des Produkttyps: **DoP: 0142**
2. Verwendungszweck(e): **Zur Verwendung in Systemen, wie z.B. Fassadensystemen, zur Befestigung oder Verankerung von Elementen, die zur Stabilität der Systeme beitragen, siehe Anhang, insbesondere Anhänge B 1 bis B 4**
3. Hersteller: **fischerwerke GmbH & Co. KG, Klaus-Fischer-Straße 1, 72178 Waldachtal, Deutschland**
4. Bevollmächtigter: --
5. System(e) zur Bewertung und Überprüfung der Leistungsbeständigkeit: **2+**
6. Europäisches Bewertungsdokument: **ETAG 020, 2012-03**

Europäische Technische Bewertung: **ETA-13/0235; 2018-05-31**

Technische Bewertungsstelle: **ETA-Danmark A/S**

Notifizierte Stelle(n): **1343 – MPA Darmstadt**

7. Erklärte Leistung(en):

**Mechanische Festigkeit und Standsicherheit (BWR 1), Sicherheit und Barrierefreiheit bei der Nutzung (BWR 4)**

- **Charakteristische Werte für Zug- und Querbeanspruchung:** Siehe Anhang, insbesondere Anhänge C 1 bis C 2
- **Charakteristische Biegemomente:** Siehe Anhang, insbesondere Anhänge C 1
- **Verschiebungen unter Zug- und Querbeanspruchung:** Siehe Anhang, insbesondere Anhang C 1
- **Dübelabstände und Bauteilabmessungen:** Siehe Anhang, insbesondere Anhänge B 2 bis B 3

**Brandschutz (BWR 2)**

- **Brandverhalten:** Der Dübel erfüllt die Anforderungen der Klasse A 1
- **Feuerwiderstand:** Siehe Anhang, insbesondere Anhang C 1

8. Angemessene Technische Dokumentation und/oder Spezifische Technische Dokumentation: ---

Die Leistung des vorstehenden Produkts entspricht der erklärten Leistung/den erklärten Leistungen. Für die Erstellung der Leistungserklärung im Einklang mit der Verordnung (EU) Nr. 305/2011 ist allein der obengenannte Hersteller verantwortlich.

Unterzeichnet für den Hersteller und im Namen des Herstellers von:

Andreas Bucher, Dipl.-Ing.

Wolfgang Hengesbach, Dipl.-Ing., Dipl.-Wirtsch.-Ing.

*i.V. A. Bucher*

*i.V. W. Hengesbach*

Tumlingen, 2018-06-06

- Diese Leistungserklärung wurde in verschiedenen Sprachversionen erstellt. Für den Fall unterschiedlicher Auslegung hat immer die englische Version Vorrang.
- Der Anhang enthält freiwillige und ergänzende Informationen in englischer Sprache. Diese gehen über die (sprachneutral angegebenen) gesetzlichen Anforderungen hinaus.

## **II SPECIFIC PART OF THE EUROPEAN TECHNICAL ASSESSMENT**

### **1 Technical description of product and intended use**

#### **Technical description of the product**

Fischer FUR 10 is a plastic anchor consisting of a plastic sleeve made of polyamide and an accompanying specific screw of galvanised steel or galvanized steel with an additional Duplex-coating or of stainless steel.

The plastic sleeve is expanded by screwing in the specific screw which presses the sleeve against the wall of the drilled hole.

The installed anchor is shown in Annex 1

### **2 Specification of the intended use in accordance with the applicable EAD**

The performances given in Section 3 are only valid if the anchor is used in compliance with the specifications and conditions given in Annex B.

The verifications and assessment methods on which this European Technical Assessment is based lead to the assumption of a working life of the anchors of at least 50 years.

The indications given on the working life cannot be interpreted as a guarantee given by the producer, but are to be regarded only as a means for choosing the right products in relation to the expected economically reasonable working life of the works.

### **3 Performance of the product and references to the methods used for its assessment**

#### **3.1 Mechanical resistance and stability (BWR 1)**

The essential characteristics regarding mechanical resistance and stability are included under the Basic Works Requirement Safety in use

#### **3.2 Safety in case of fire (BWR 2)**

Reaction to fire Anchorages satisfy requirements for Class A 1  
Resistance to fire See Annex C 1

#### **3.3 Safety and accessibility (BWR 4)**

Characteristic resistance for tension and shear loads, see Annexes C 1, C 2  
Characteristic resistance for bending moments, see Annex C 1  
Displacements under shear and tension loads, see Annex C 1  
Anchor distances and dimensions of members, see Annex B 2 and B3.

#### **3.4 General aspects**

The verification of durability is part of testing the essential characteristics.

Durability is only ensured if the specifications of intended use according to Annex B are taken into account.

## **4 Attestation and verification of constancy of performance (AVCP)**

### **4.1 AVCP system**

In accordance with guideline for European technical approval ETAG 020, March 2012 used as European Assessment Document (EAD) according to Article 66 Paragraph 3 of Regulation (EU) No 305/2011 the applicable European legal act is: 97/463/EC. The system to be applied is 2+.

**fischer frame fixing FUR**

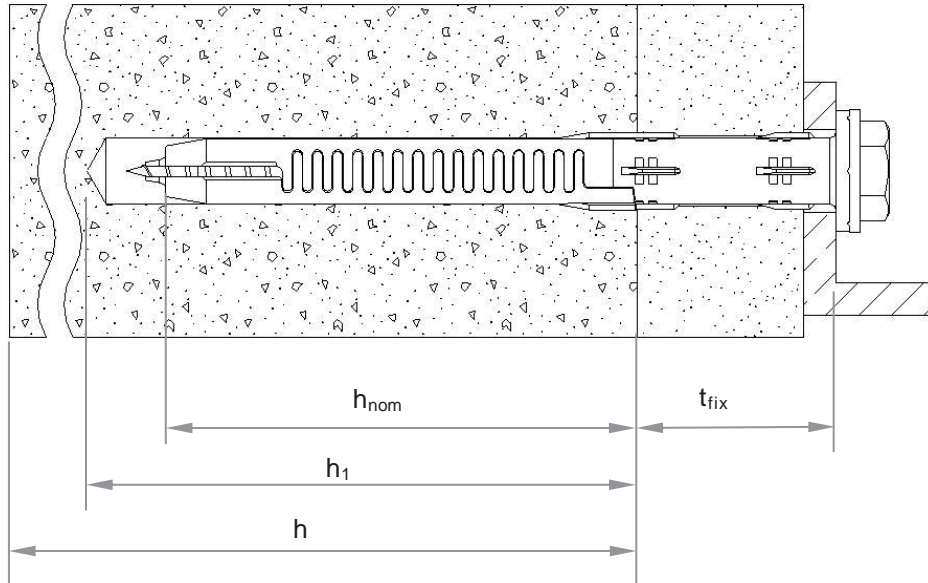

**Intended Use**

Fixing in concrete and different kinds of masonry

**Legend**

- $h_{nom}$  = overall plastic anchor embedment depth in the base material
- $h_1$  = depth of drill hole to deepest point
- $h$  = thickness of member (wall)
- $t_{fix}$  = thickness of fixture and / or non-load bearing layer

Figures not to scale

**fischer long shaft fixing FUR**

**Annex A 1**

**Product description**  
Installed anchor

**FUR**

Anchor sleeve  
countersunk version:

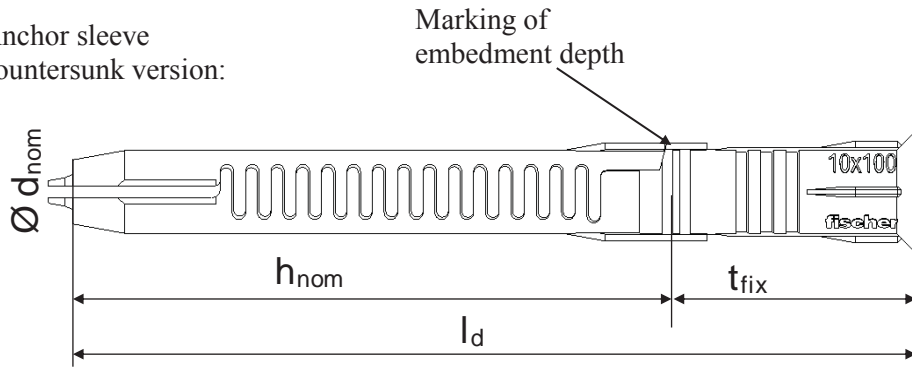

Marking:  
Brand  
Anchor type  
Size  
e.g. FUR 10x100

flat-collar version:

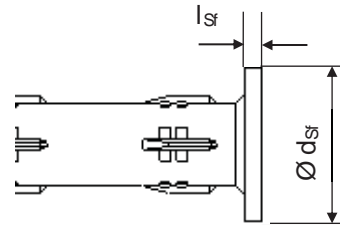

Special screw:

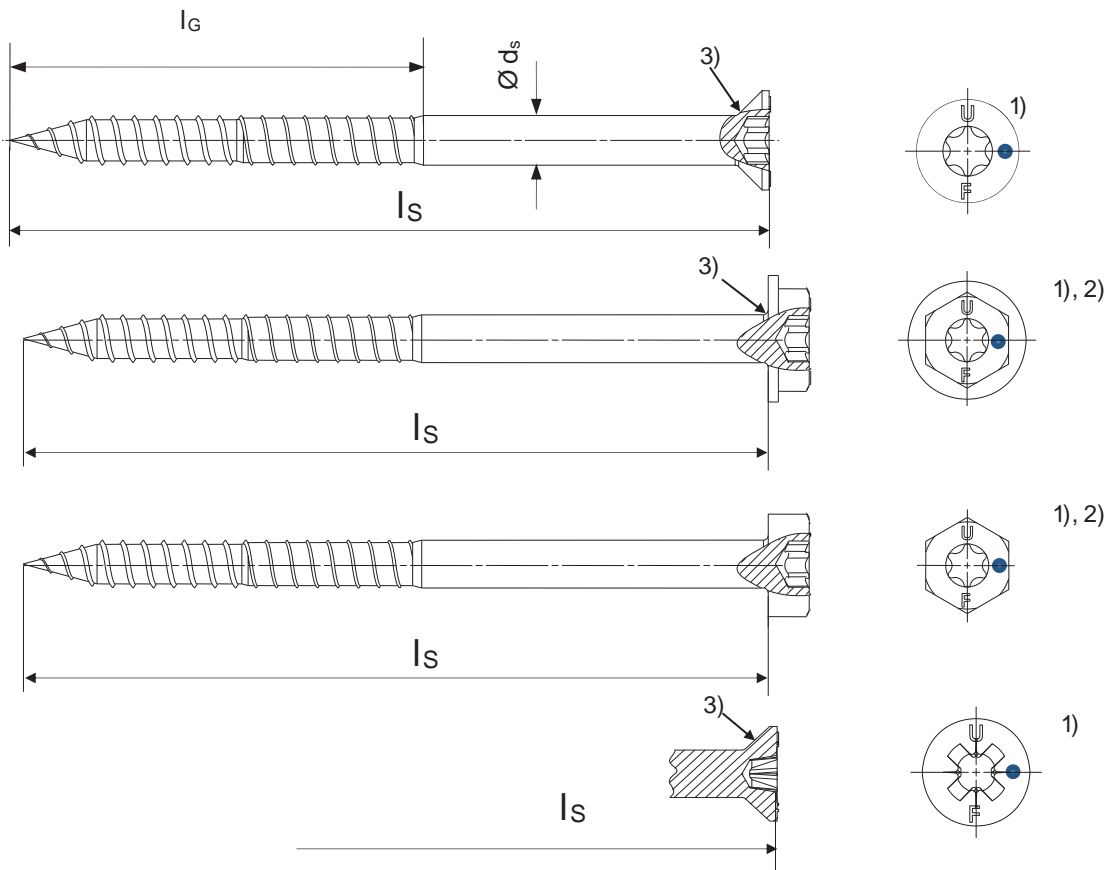

- 1) Additional marking of the special stainless-steel screw: „A4“.
- 2) Internal driving feature for Torx bit is optional for hexagonal head
- 3) Optional additional version with underhead ribs

Figures not to scale

**fischer long shaft fixing FUR**

**Annex A 2**

**Product description**  
Anchor types / special screws

**Table A3.1: Dimensions [mm]**

Anchor type	Anchor sleeve [mm]						Special screw [mm]		
	$h_{nom}$	$\varnothing d_{nom}$	$t_{fix}$	$l_d$	$l_{sf}^{2)}$	$\varnothing d_{sf}$	$\varnothing d_s$	$l_G$	$l_s$
<b>FUR 10</b>	<b>70</b>	<b>10</b>	$\geq 1$	<b>71-360</b>	<b>2,2</b>	<b>18,5</b>	<b>7,0</b>	$\geq 77$	$\geq 78^{1)}$

1) To ensure that the screw penetrates the anchor sleeve,  $l_s$  must be  $l_d + l_{sf}^{2)} + 7$  mm

2) Only valid for flat collar version

**Table A3.2: Materials**

Name	Material
Anchor sleeve	Polyamide, PA6, colour grey
Special screw	- Steel gvz A2G or A2F acc. to EN ISO 4042:2001 <b>or</b> - Steel gvz A2G or A2F acc. to EN ISO 4042:2001+ Duplex-coating type Delta-Seal in three layers (total layer thickness $\geq 6 \mu\text{m}$ ) <b>or</b> - Stainless steel acc. to EN 10 088-3:2014, e.g. 1.4401, 1.4571, 1.4578, 1.4362

**fischer long shaft fixing FUR**

**Annex A 3**

**Product description**  
Dimension / Materials

**Specifications of intended use**

**Anchorage subject to:**

- Static and quasi-static loads.
- Multiple fixing of non-structural applications.

**Base materials:**

- Reinforced or unreinforced normal weight concrete with strength classes  $\geq$  C12/15 (use category “a”), according to EN 206-1:2000, Annex C1.
- Solid brick masonry (use category “b”), according to Annex C2.  
Note: The characteristic resistance is also valid for larger brick sizes and higher compressive strengths of the masonry unit.
- Hollow brick masonry (use category “c”), according to Annex C2.
- Mortar strength class of the masonry  $\geq$  M2,5 according to EN 998-2:2010.
- For other base materials of the use categories “a”, “b” or “c” the characteristic resistance of the anchor may be determined by job site tests according to ETAG 020, Annex B, Edition March 2012.

**Temperature Range:**

FUR 10

- c: - 20 °C to 50 °C (max. short term temperature + 50 °C and max long term temperature + 30 °C)
- b: - 20 °C to 80 °C (max. short term temperature + 80 °C and max long term temperature + 50 °C)

**Use conditions (Environmental conditions):**

- Structures subject to dry internal conditions (zinc coated steel, stainless steel).
- The specific screw made of galvanised steel or galvanised steel with an additional Duplex-coating may also be used in structures subject to external atmospheric exposure, if the area of the head of the screw is protected against moisture and driving rain after mounting of the fixing unit in this way, that intrusion of moisture into the anchor shaft is prevented. Therefore there shall be an external cladding or a ventilated rainscreen mounted in front of the head of the screw and the head of the screw itself shall be coated with a soft plastic, permanently elastic bitumen-oil-combination coating (e.g. undercoating or body cavity protection for cars).
- Structures subject to external atmospheric exposure (including industrial and marine environment) and to permanently damp internal condition, if no particular aggressive conditions exist (stainless steel).  
Note: Particular aggressive conditions are e.g. permanent, alternating immersion in seawater or the splash zone of seawater, chloride atmosphere of indoor swimming pools or atmosphere with extreme chemical pollution (e.g. in desulphurization plants or road tunnels where de-icing materials are used).

**Design:**

- The anchorages are to be designed in accordance with the ETAG 020, Annex C under the responsibility of an engineer experienced in anchorages and masonry work.
- Verifiable calculation notes and drawings shall be prepared taking account of the loads to be anchored, the nature and strength of the base materials and the dimensions of the anchorage members as well as of the relevant tolerances. The position of the anchor is indicated on the design drawings.
- Fasteners are only to be used for multiple use for non-structural application, according to ETAG 020, Edition March 2012.

**Installation:**

- Hole drilling by the drilling method according to Annex C1 and C2 for use categories “b” and “c”.
- Anchor installation carried out by appropriately qualified personnel and under the supervision of the person responsible for technical matters of the site.
- Installation temperature FUR 10: **- 20 °C to + 40 °C**
- Exposure to UV due to solar radiation of the not protected anchor  $\leq$  6 weeks.

<b>fischer long shaft fixing FUR</b>	<b>Annex B 1</b>
<b>Intended use Specifications</b>	



**Table B1.1: Installation parameters**

Anchor type		FUR 10
Drill hole diameter	$d_0 =$ [mm]	10
Cutting diameter of drill bit	$d_{cut} \leq$ [mm]	10,45
Depth of drill hole to deepest point <sup>1)</sup>	$h_1 \geq$ [mm]	85
Overall plastic anchor embedment depth in the base material <sup>1) 2)</sup>	$h_{nom} \geq$ [mm]	70
Diameter of clearance hole in the fixture	$d_f \leq$ [mm]	12,5

1) See Annex 1

2) If the embedment depth is higher than  $h_{nom}$  given in Table B1.1 (only for hollow and perforated masonry), job site tests have to be carried out according to ETAG 020, Annex B.

**Table B1.2: Minimum thickness of member, edge distance and spacing in concrete**

Anchor type		Minimum thickness of member $h_{min}$ [mm]	Characteristic edge distance $c_{cr,N}$ [mm]	Characteristic spacing $s_{cr,N}$ [mm]	Minimum allowable spacing and edge distances <sup>1)</sup> [mm]
FUR 10	Concrete $\geq$ C16/20	110	100	80	$s_{min} = 50$ for $c \geq 100$ $c_{min} = 50$ for $s \geq 150$
	Concrete C12/15		140	90	$s_{min} = 70$ for $c \geq 140$ $c_{min} = 70$ for $s \geq 210$

1) Intermediate values by linear interpolation

FUR 10: In case a fixing point consists of more than 1 anchor with spacing of  $s \leq s_{cr,N}$ , this fixing point is considered as a group with a max. characteristic resistance  $N_{Rk,p}$  acc. to Table 6.

For  $s > s_{cr,N}$ , the anchors are always considered as single anchors, each with a characteristic resistance  $N_{Rk,p}$  acc. to Table 6.

**Scheme of distance and spacing in concrete**

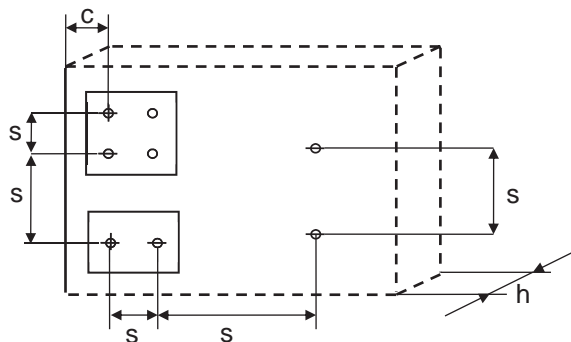

Figures not to scale

**fischer long shaft fixing FUR**

**Annex B 2**

**Intended use**

Installation parameters, minimum thickness, edge distances and spacings

**Table B2.1: Minimum distances and dimensions in masonry**

Anchor type			FUR 10
Minimum thickness of member	$h_{min}$	[mm]	110
Single anchor			
Minimum allowable spacing	$s_{min}$	[mm]	250
Minimum allowable edge distance	$c_{min}$	[mm]	100
Anchor Group			
Minimum allowable spacing perpendicular to free edge	$s_{1,min}$	[mm]	100
Minimum allowable spacing parallel to free edge	$s_{2,min}$	[mm]	100
Minimum allowable edge distance	$c_{min}$	[mm]	100

**Scheme of distance and spacing in masonry**

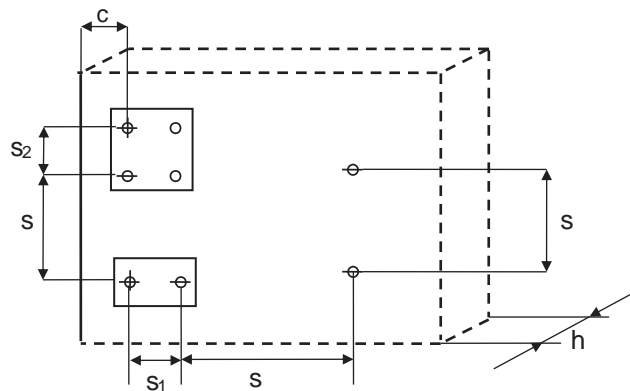

Figures not to scale

**fischer long shaft fixing FUR**

**Annex B 3**

**Intended use**

Minimum distances and dimensions in masonry

**Installation Instructions (the following pictures show fixing through timber parts)**

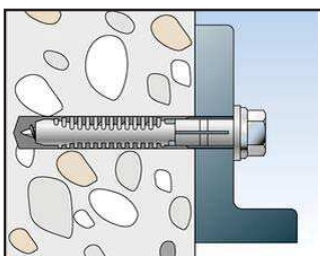
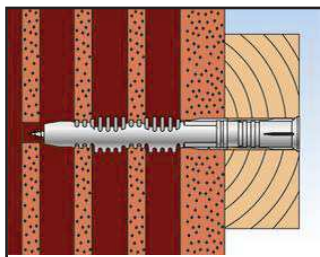
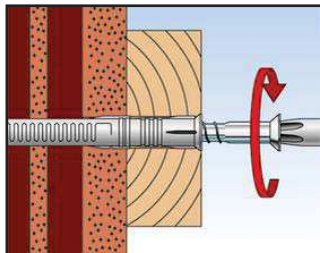
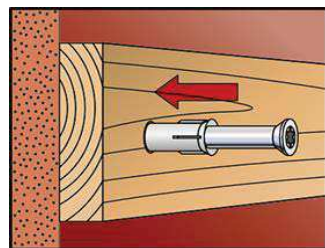
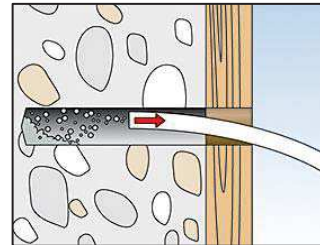
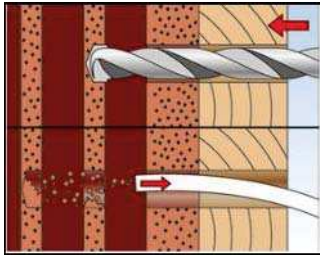

1. Drill the bore hole acc. to Table B1.1 using the drill method described in the corresponding Annex C.

2. Remove dust from borehole (masonry and concrete).

3. Insert anchor (screw and plug) by using a hammer until the collar of the plastic sleeve is flush with the surface of the fixture.

4. The screw is screwed-in until the head of the screw touches the sleeve. The anchor is correctly mounted, when the head of the screw fits tight on the surface and cannot be screwed-in any further.

5. Correctly installed anchor in hollow masonry.

6. Correctly installed anchor in concrete.

Figures not to scale

**fischer long shaft fixing FUR**

**Annex B 4**

**Intended use**  
Installation instructions

**Table C1.1: Characteristic bending resistance of the screw in concrete and masonry**

Anchor type		FUR 10	
Material		galvanised steel	stainless steel
Characteristic bending resistance	$M_{Rk,s}$ [Nm]	17,7	17,1
Partial safety factor	$\gamma_{Ms}$ <sup>1)</sup>	1,25	1,29

<sup>1)</sup> In absence of other national regulations

**Table C1.2: Characteristic resistance of the screw for use in concrete**

Failure of expansion element (special screw)		FUR 10	
		galvanized steel	stainless steel
Characteristic tension resistance	$N_{Rk,s}$ [kN]	18,7	18,1
Partial safety factor	$\gamma_{Ms}$ <sup>1)</sup>	1,50	1,55
Characteristic shear resistance	$V_{Rk,s}$ [kN]	9,4	9,0
Partial safety factor	$\gamma_{Ms}$ <sup>1)</sup>	1,25	1,29

<sup>1)</sup> In absence of other national regulations

**Table C1.3: Characteristic resistance for use in concrete (use categorie “a”)**

Pull-out failure (plastic sleeve)		FUR 10
Concrete $\geq$ C12/15		
Characteristic resistance	$N_{Rk,p}$ [kN]	4,5
Partial safety factor	$\gamma_{Mc}$ <sup>1)</sup>	1,8

<sup>1)</sup> In absence of other national regulations

**Table C1.4: Displacements under tension und shear loading in concrete<sup>1)</sup>, masonry<sup>1)</sup>**

Anchor type	F <sup>2)</sup> [kN]	Tension load		Shear load	
		$\delta_{NO}$ [mm]	$\delta_{N\infty}$ [mm]	$\delta_{v0}$ [mm]	$\delta_{v\infty}$ [mm]
FUR 10	1,8	0,62	1,24	3,39	5,09

1) Valid for all ranges of temperatures

2) Intermediate values by linear interpolation

**Table C1.5: Values under fire exposure in concrete C20/25 to C50/60 in any load direction no permanent centric tension load and without lever arm**

Anchor type	Fire resistance class	F <sup>1)</sup>
FUR 10	R 90	$\leq 0,8$ kN

<sup>1)</sup>  $F_{Rk} / (\gamma_m \times \gamma_F)$

**fischer long shaft fixing FUR**

**Annex C 1**

**Performances**

Characteristic resistance and characteristic bending resistance of the screw  
Characteristic resistance for use in concrete and values under fire exposure

**Table C2.1: FUR 10 characteristic resistance  $F_{RK}$  in [kN] in solid and hollow masonry (use category “b” and “c”)**

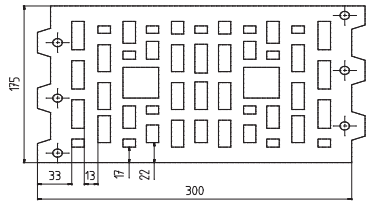
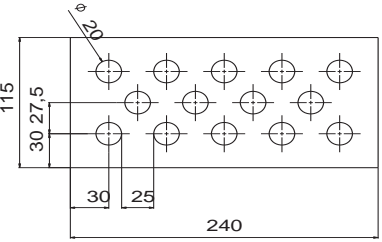
Base material [Supplier Title]	Use Cat.	Geometry and min. DF or min. size (L x W x H) and drilling method  [mm]	min. compressive strength $f_b$ [N/mm <sup>2</sup> ] / bulk density $\geq \rho$ [kg/dm <sup>3</sup> ]	Characteristic resistance $F_{RK}$ <b>FUR 10</b> [kN]
				30/50 °C 50/80 °C
Clay solid brick <b>Mz</b> , e.g. acc. to EN 771-1:2011 e.g. <b>Schlagmann</b>	b	NF (240x113x71) by hammer drilling	12/1,8	<b>3,0</b>
			10/1,8	<b>2,5</b>
			8/1,8	<b>2,0</b>
Calcium silicate solid brick KS, acc. to EN 771-2:2011, e.g. <b>KS Wending</b>	b	NF (240x113x71) by hammer drilling	20/1,8	<b>2,5</b>
			10/1,8	<b>2,0</b>
			8/1,8	<b>1,5</b>
		(500x175x235) by hammer drilling	12/1,8	<b>3,5</b>
			10/1,8	<b>3,0</b>
			8/1,8	<b>2,5</b>
Lightweight solid brick, <b>Vbl</b> acc. to EN 771-3:2011, e.g. <b>KLB</b>	b	(250x240x245) by hammer drilling	8/1,6	<b>3,0</b>
			6/1,6	<b>2,0</b>
Clay brick Form B, <b>HLz</b> acc. to EN 771-1:2011	c	 by rotary drilling	20/1,4	<b>2,0</b>
			16/1,4	<b>1,7</b>
			12/1,4	<b>1,3</b>
			10/1,4	<b>1,0</b>
Hollow calcium silicate brick <b>KSL</b> , acc. to EN 771- 2:2011, e.g. <b>KS Wending</b>	c	 2 DF (240x115x113) by hammer drilling	16/1,6	<b>2,5</b>
			12/1,6	<b>2,0</b>
			10/1,6	<b>1,5</b>
<b>Partial safety factor</b> <sup>1)</sup>			$\gamma_{Mm}$	<b>2,5</b>

<sup>1)</sup> In absence of other national regulations

Figures not to scale

**fischer long shaft fixing FUR**

**Annex C 2**

**Performances**

Characteristic resistance in masonry (cat. “b” and “c”)